

HARDNESS TESTERS

Overview of Bench & Floor type machines



INDEX

© INNOVATEST Europe BV

Edition: C18CAT/09/EN

Bench & Floor type hardness testing 2019.

Changes in products and/or product specifications can emerge due to new technologies and continuous development. We reserve the right to change or modify specifications of products without prior notice. We recommend you to contact our sales office for up-to-date information.

All dimensions in this catalogue are in mm, approximate. Working heights and or workpiece accommodation varies depending on the stages and stage accessories used.

Please contact our sales department for more details.

© All rights reserved Trademarks:

INNOVATEST®, INNOVATECH®, MASTERBLOCK®, IMPRESSIONS™ are trade names of INNOVATEST/INNOVATECH Group of Companies. All other brands and trade names are the unconditional property of their respective owners.

ABOUT INNOVATEST	4
VICKERS TESTING METHOD	6
VICKERS HARDNESS TESTERS OVERVIEW	8
FALCON 400/450	10
FALCON 500	12
FALCON 600	13
FALCON 5000	16
ROCKWELL TESTING METHOD	18
ROCKWELL HARDNESS TESTERS OVERVIEW	20
FENIX 200AR/ACL	22
NEXUS 605/610	23
VERZUS 710	24
NEMESIS 6100/6200	26
NEMESIS 9100RS(B)	28
BRINELL TESTING METHOD	30
BRINELL HARDNESS TESTERS OVERVIEW	31
NEXUS 3100/3200	34
NEXUS 3001XLM-IMP	35
NEXUS 3300-3400M	36
NEXUS 3300-3400FA	37
NEXUS 8103RSB/XLM-RSB	38
NEMESIS 9600RS(B)	39
HARDNESS TESTING UNIVERSAL	40
UNIVERSAL HARDNESS TESTERS OVERVIEW	42
NEXUS 605U	44
VERZUS 750CCD	44
NEXUS 7700	45
NEMESIS 5100	46
NEMESIS 9100	48
NEXUS 8100/8100XL	50
NEMESIS 9600	52
NEMESIS 9800	53
TEST HEADS	54
OVERVIEW LAB TESTERS	58
STARTING WITH I-TOUCH	60
FEATURED BY IMPRESSIONS™	62
REFERENCE BLOCKS & INDENTERS	64
BENCH STANDS	66

ABOUT

LEADING MANUFACTURER IN

HARDNESS TESTING MACHINES

LOAD CELL, CLOSED LOOP TECHNOLOGY

All INNOVATEST hardness testing machines incorporate load cell closed loop technology. This sophisticated load application system is far superior to any dead weight systems, but also superior to any other electronic force application systems that does not incorporate "force feedback" control. The force feedback system is the ultimate guarantee that no force "overshoot" takes place during the entire testing procedure. Without force feedback control, any (electronic/deadweight) system could provide more force than allowed and eventually create incorrect hardness readings.

Unique in the industry, INNOVATEST designs and manufactures its own load cells and load cell amplifiers. In this way, not making use of standard products, we assure the force that needs to be applied is controlled by a system that is developed for its purpose, assuring the best possible specifications and is not hindering us in product development from shape or design point of view.

ADVANCED SOFTWARE APPLICATIONS

The Graphical User interface (GUI) of our hardness testers contains industry preferred applications and offers easy to learn, advanced workflow control. A simple test can be set up and conducted in about 3 seconds...IMPRESSIONS™ layout & functions will not only match your particular application requirements, but also meet the needs and preferences of your operators. A user level management system maximizes their comfort and efficiency.



INNOVATEST

SETTING NEW BOUNDARIES

While our history within the industry goes back as far as 1890, our focus on technology and progress in the hardness testing field has significantly evolved in the past decade.

Recognized and trusted by scientists, engineers, laboratories and the general metal and plastics industry worldwide, INNOVATEST products and services for hardness testing procedures are continuously setting new boundaries.

Test and product development professionals rely on INNOVATEST to create and optimize their designs. Around the world, test engineers in laboratories recognize our highly efficient hardness testing machines and software to be used for a wide range of components and materials.

Whether your requirement is to evaluate advanced components made of steel, alloys or plastic, used for commercial transportation vehicles, air-and space crafts, bridges, or buildings, orthopedic or dental labs, or you wish to secure testing results for standard production parts or in-line testing, INNOVATEST hardness testing solutions facilitate many of the innovations required by the fast changing world around us.

Our global presence supports customers with sophisticated supply chain management to obtain actually comparable testing results, regardless of the location.

For the most demanding professionals and laboratories, our new range of standardizing or reference hardness testers are no longer exotic products, but just a part of our general supply range.

We invite you to discover and explore our leading range of hardness testing machines and the excellent service capabilities for installation and after sales service support.

STAY ABOVE THE CURRENT, RELY ON INNOVATEST, BE CERTAIN!

RELIABILITY

PROBLEM-SOLVING QUALITY

VICKERS TESTING METHOD

The Vickers hardness test was developed in 1924 by Smith and Sandland at Vickers Ltd as an alternative to the Brinell method to measure the hardness of materials. The Vickers test is often easier to use than other hardness tests, since the required calculations are independent of the size of the indenter, and the indenter can be used for all materials irrespective of hardness.

The basic principle, as with all common measures of hardness, is to observe the questioned material's ability to resist plastic deformation from a standard source. The Vickers test can be used for all metals and has one of the widest scales among hardness tests. The unit of hardness given by the test is known as the Vickers Pyramid Number (HV) or Diamond Pyramid Hardness (DPH).

The indenter shape should be capable of producing geometrically similar impressions, irrespective of size; the impression should have well-defined points of measurement; and the indenter should have high resistance to self-deformation. A diamond in the form of a square-based pyramid satisfied these conditions.

Vickers hardness numbers are reported as xxxHVyy, e.g. 440HV30, or xxxHVyy/zz if duration of force differs from 10s to 15s, e.g. 440Hv30/20, where:

- 440 is the hardness number,
- HV gives the hardness scale (Vickers),
- 30 indicates the load used in kg.
- 20 indicates the loading time if it differs from 10s to 15s

Vickers values are generally independent of the test force: they will come out the same for 500gf and 50kgf, as long as the force is at least 200gf. The hardness number is not really a true property of the material and is an empirical value that should be seen in conjunction with the experimental methods and hardness scale used. When doing a Vickers hardness test the distance between indentations must be more than 2.5 indentation diameters apart to avoid interaction between the work-hardened regions.

Examples of HV values for various materials :

Material	Value
316L stainless steel	140 HV30
347L stainless steel	180 HV30
Carbon steel	55 - 120HV5
Iron	30 - 80HV5

STANDARDS

- European & international EN ISO 6507
- American ASTM E384/E92

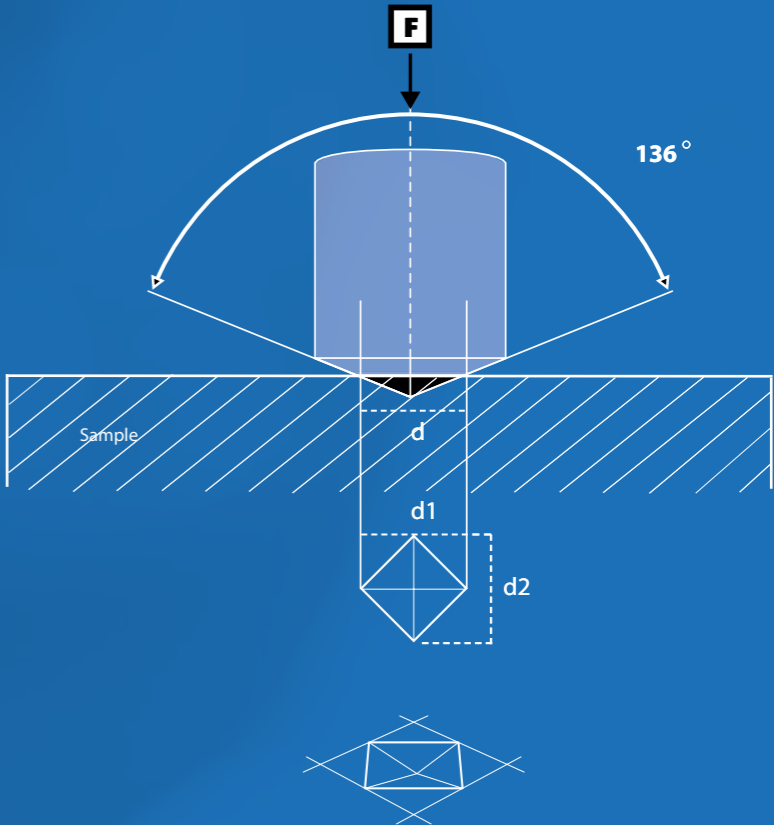

VICKERS HARDNESS TESTERS

OVERVIEW

MANUAL, AUTOMATIC, OR FULLY AUTOMATED

A wide range of machines, all equipped with the unique INNOVATEST Multi Load Cell, closed Loop force application system. Fit to any budget, fit for any purpose, our testers can be freely configured to your requirements.

Each of our machines can be updated and upgraded, even years after original purchase. Manual or motorized stages, camera systems, stage overview systems, optics or software. Buy fully configured, or update later.

STANDARD



OPTIONAL



UNIQUE STRUCTURE, BALL BEARING Z-AXIS...

Vickers hardness testers are routinely used for testing materials, components or parts in the aerospace and automotive industry, laboratories for sample evaluation, to conduct common or advanced testing tasks.

The wide choice of test force configurations ranging from a stunning 0.1gf up to 150kgf makes the FALCON series to the most powerful in its range. Software is key in the efficient operating of hardness testing machines. The IMPRESSIONS™ user interface leads in performance and set-up speed.



FALCON 400



FALCON 450



FALCON 500



FALCON 600



FALCON 5000

FALCON 400/450

HIGHLIGHTS :

FALCON 400



SCALES	Micro Vickers, Vickers, Knoop Brinell.
TEST FORCES	1gf - 31.25kgf (multi load cell, closed loop).
EYEPIECE	10X or 15X magnifying eyepiece.
OBJECTIVES	5X, 10X, 20X, 50X, 100X.
6 POSITION TURRET	2 indenters, 4 objectives.
ILLUMINATION	Power LED.
CONTROL	i-Touch full color touch screen.
Z-AXIS	Manually operated, fine adjustable on the side.
XY-STAGE	Manual, 100mm X 100mm, travel 25mm X 25mm.
WORKPIECE ACC.	150mm (H) X 170mm (D).
OUTPUT	USB.
CAMERA & AUTOM.	Optional IMPRESSIONS™ automation packages, camera mounted invisibly under top cover.

FALCON 450



SCALES	Micro Vickers, Vickers, Knoop Brinell.
TEST FORCES	10gf - 62.5kgf (multi load cell, closed loop).
EYEPIECE	10X or 15X magnifying eyepiece.
OBJECTIVES	5X, 10X, 20X, 50X, 100X.
6 POSITION TURRET	2 indenters, 4 objectives.
ILLUMINATION	Power LED.
CONTROL	i-Touch full color touch screen.
Z-AXIS	Manually operated, with dynamic handwheel on spindle. Anvil 60mm : standard.
XY-STAGE	Manual, 100mm X 100mm, travel 25mm X 25mm (optional).
WORKPIECE ACC.	260mm (H) X 170mm (D).
OUTPUT	USB.
CAMERA & AUTOM.	Optional IMPRESSIONS™ automation packages, camera mounted invisibly under top cover, motorized stages.

INNOVATIVE SOFTWARE FUNCTIONS

Full color touch screen, swivable table stand, smart graphical user interface, large memory for readings, automatic hardness calculation, 3 simultaneously conversions to other hardness scales, program mode and many more.

Camera & automation : Optional IMPRESSIONS™ automation packages, camera mounted invisibly under top cover.



IMPRESSIONS™

AUTOMATION PACKAGES

STANDARD PACKAGE (IMP-2)

High resolution 5 Megapixels integrated camera system, industrial 15" HD touch screen, mouse and keyboard. Includes power full system controller, there is no additional PC required. The standard automatic indent measurement system reduces overall testing time and improves operator repeatability. The system communicates with tester and controls the entire testing procedure.

ADVANCED PACKAGE (IMP-3 & 4)

As STANDARD package, additionally offers two options:

A) IMP-3 has one digital micrometer X-axis that transfers the position of the stage to IMPRESSIONS™.

B) IMP-4 has two digital micrometers that transfer the position of the stage to IMPRESSIONS™.

PREMIUM PACKAGE (IMP-5)

As STANDARD package, additionally includes advanced software modules for CHD/SHD/NHD, pattern testing and automatic edge detection. Moreover this option includes a high-speed CNC motorized XY-stage, travel 120mm X 100mm which can carry 400kgf load.



FALCON 500

UNPARALLELED CONFIGURATION FREEDOM...

The FALCON 500 offers a leading technology base for manual, automatic or fully automated testing of Micro and Macro Vickers, Knoop or Brinell assignments.

With a wide choice of test force configurations, answering any possible imagination, the FALCON 500 can be completed with fully integrated hardware options to assure a match with the particular testing tasks of your industry. Coming from a leading edge of mechanical design, the load cell, closed loop system of the base unit can be completed with manual or digital micrometers or for more testing comfort, with motorized CNC stages.

The unique motorized ball bearing Z-axis provides accurate height movement and high speed autofocus. The user interface provides manual & automatic measurement and a wide selection of standard and optional testing applications, supporting a high resolution (HD) camera and a second (optional) full work stage overview camera.

HIGHLIGHTS :

SCALES	Micro Vickers, Vickers, Knoop, Brinell.
TEST FORCES	1gf - 62.5kgf (multi load cell, closed loop).
CAMERA	5 Megapixels, Full HD camera system, with zoom & auto-focus.
OVERVIEW CAMERA	Optional Full HD optical zoom stage overview camera.
OBJECTIVES	2.5X, 5X, 10X, 20X, 50X, 100X.
6 POSITION TURRET	2 indenters, 4 objectives, with collision detection system.
ILLUMINATION	Power LED.
CONTROL	Fully integrated i7 Controller, Windows 10 operated, 15" industrial touch screen, IMPRESSIONS™ advanced workflow software, includes automatic measurement, stage control & pattern configurator, keyboard & mouse.
Z-AXIS	CNC motorized, ball bearing slide, with fast up down and digital scroll wheel for fine adjustment.
XY-STAGE	Manual, 100 X 100mm, travel 25 X 25mm or CNC motorized, several options.
WORKPIECE ACC.	200mm (H) X 170mm (D).
OUTPUT	USB, LAN, Bluetooth.
SOFTWARE	Large choice of software options, features, plug ins and add-ons, Q-DAS certified.



FALCON 600

PRE-CONFIGURED, FULLY AUTOMATED

The FALCON 600 Automated Hardness Testing System provides a fully integrated platform for your complete Vickers, Knoop & Low Force Brinell hardness testing needs.

Coming from a leading edge of mechanical design, with a range of CNC stages and best in class optics, 18 Megapixels, 4K, full color image technology, to a fully featured, easy to use, User Interface.

Standard force range of 1gf to 62.5kgf, optional going down to forces as low as 0.1gf, to be used in combination with any thinkable software application, provides a micro hardness testing machine for today, tomorrow and better...for the future.

HIGHLIGHTS :

SCALES	Micro Vickers, Vickers, Knoop, Brinell.
TEST FORCES	1gf - 62.5kgf (multi load cell, closed loop).
CAMERA	18 Megapixels, 4K, Full HD camera system, with zoom and auto-focus.
OVERVIEW CAMERA	Standard Full HD optical zoom stage overview camera
OBJECTIVES	2.5X, 5X, 10X, 20X, 50X, 100X.
6 POSITION TURRET	2 indenters, 4 objectives, with collision detection system.
ILLUMINATION	Power LED.
CONTROL	Fully integrated i7 Controller, Windows 10 operated, 15" industrial touch screen, IMPRESSIONS™ advanced workflow software, includes automatic measurement, stage control & pattern configurator, keyboard & mouse.
Z-AXIS	CNC motorized, ball bearing slide, with fast up down and digital scroll wheel for fine adjustment.
XY-STAGE	Standard CNC motorized stage 300mm X 225mm.
JOYSTICK	X-Y-Z control over integrated joystick.
WORKPIECE ACC.	200mm (H) X 170mm (D).
OUTPUT	USB, LAN, Bluetooth.
SOFTWARE	Large choice of software options, features, plug-ins and add-ons, Q-DAS certified.

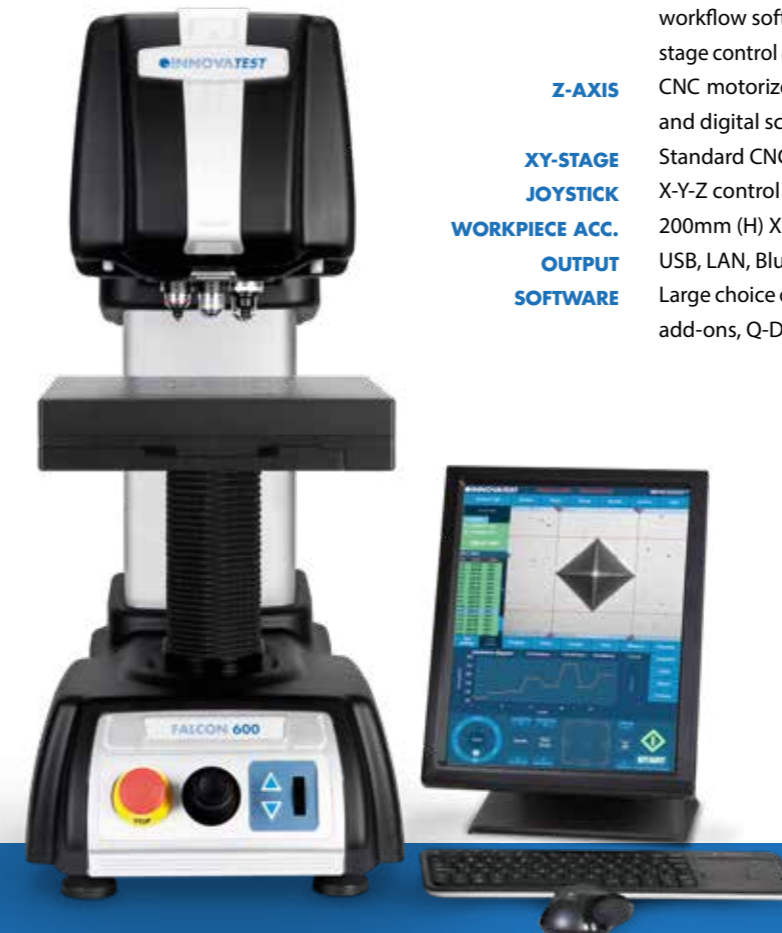



MEET THE

FALCON 5000

It's not about ideas, it's about making ideas happen...

Sophisticated and unique, 100% linear, vertical force actuator. Cutting edge technology, high speed turret with integrated multi load cell signal handling, stage overview camera at indenter position, power LED TTL illumination, positioning laser and an advanced collision detection and test head retraction system.

FALCON 5000

HIGHLIGHTS :

SCALES	Micro Vickers, Vickers, Knoop, Brinell.
TEST FORCES	10gf - 187.5kgf (multi load cell, closed loop).
CAMERA	18 Megapixels, Full HD camera system, with zoom and auto-focus.
OVERVIEW CAMERA	Full HD optical zoom stage overview camera.
OBJECTIVES	2.5X, 5X, 10X, 20X, 40X, 60X, 100X.
8 POSITION TURRET	2 indenters, 4 objectives, Class 2 laser for positioning and optional integrated overview camera.
ILLUMINATION	Power LED.
CONTROL	Fully integrated i7 Controller, Windows 10 operated, 15" industrial touch screen, IMPRESSIONS™ advanced workflow software, includes automatic measurement, stage control & pattern configurator, keyboard & mouse.
Z-AXIS	Descending test head, with collision detection, CNC motorized, ball bearing slide, with fast up down and digital scroll wheel for fine adjustment.
XY-STAGE	Manual, motorized stages or/and anvils or work tables at choice.
JOYSTICK	X-Y-Z control over integrated joystick.
WORKPIECE ACC.	150mm (H) X 230mm (D). XL model : 300mm (H) X 225mm (D).
OUTPUT	USB, LAN, Bluetooth.
SOFTWARE	Large choice of software options, features, plug-ins and add-ons, Q-DAS certified.



THE CUTTING EDGE, OF THE LEADING EDGE...

The FALCON 5000 Series Micro Hardness testing systems provide exceptional performance and are designed with enhancements delivering unparalleled accuracy and reliability, improved ergonomics and an overall enhanced and pleasant experience for the operator.

The IMPRESSIONS™ tester control and workflow software forms an integral component of the testing system, decreasing set-up time and increasing testing efficiency. The use of programmable test patterns and specific designed software applications are developed upon the request of demanding users.

FALCON 5000 has a ball bearing spindle driven, descending test head. The work piece position is fixed and a variety of motorized stages, fixed stages or anvils can be applied.



1 POWER LED BANKS 2 PROTECTION SKIRT 3 4 OBJECTIVES 4 LASER POSITIONING SYSTEM

8 POSITION TURRET - THE MAIN CENTER OF PERFORMANCE

Designed for test forces up to 187.5kgf in the FALCON 5000 configuration, this masterpiece of mechanics and optics also incorporates load cells and electronics to handle all force application and force system feedback. It's also the home base of the high definition overview camera equipped with optical zoom system and autofocus, at indenter position. The technology of this camera provides a variable field of view of the overview, not seen in the industry before. Time consuming image stitching is therefore not required for most common samples.

This Turret technology also applies to the NEMESIS 5100 and NEMESIS 9100.

ROCKWELL TESTING

METHOD

The Rockwell hardness test was devised by metallurgist Stanley P. Rockwell in Syracuse, NY, around 1919, in order to quickly determine the effects of heat treatment on steel bearing races. The Brinell hardness test, invented in 1900 in Sweden, was slow, not useful on fully hardened steel, and left too large impressions to be considered non-destructive. Rockwell collaborated with an instrument manufacturer to commercialize his invention and develop standardized testing machines.

The Rockwell Hardness test is a hardness measurement based on the net increase in depth of impression when a load is applied. Hardness values are commonly given in the A, B, C, R, L, M, E and K scales. The higher the value in each of the scales, the harder the material.

A minor load of 3kg or 10kg is first applied, causing an initial penetration and holding the indenter in place. Then, the dial is set to zero and the major load is applied. Upon removal of the major load, the depth reading is taken while the minor load is still on. The hardness number may then be read directly from the scale. The Rockwell scale characterizes the indentation hardness of materials through the depth of penetration of an indenter, loaded on a material sample and compared to the penetration in some reference material. It is one of several definitions of hardness in materials science. Its hardness values are noted by HR'X' is the letter for the scale used. Hardness relation to strength is that both are measures of the pressure it takes to get plastic deformation to occur in materials.

OPERATION

The determination of the Rockwell hardness of a material involves the application of a minor load followed by a major load, and then noting the depth of penetration, converted to a hardness value directly from a dial or display, in which a harder material gives a higher number. The major advantage of Rockwell hardness is its ability to display hardness values directly, thus obviating tedious calculations involved in other hardness measurement techniques. Also, the relatively simple and inexpensive set-up enables installation under various conditions.

Rockwell testers are typically used in engineering, metallurgy and industrial environments. The commercial popularity arises from its speed, reliability, robustness, resolution and small area of indentation.

SCALES & VALUES

The most common used are the "C", and "B" scales. Both express hardness as an arbitrary dimensionless number. The B-scale is used for softer materials (such as aluminum, brass, and softer steels). It employs a tungsten carbide ball as the indenter and a 100-kg weight to obtain a value expressed as "HRB". The C-scale, for harder materials, uses a diamond cone and a 150-kg weight to obtain a value expressed as "HRC". There are several alternative scales for other purposes.

TYPICAL VALUES

Very hard steel (e.g. a good knife blade): HRC 55 - HRC 62 Axes, chisels, etc.: HRC 40 - 45. Several other scales, including the extensive A-scale, are used for specialized applications. There are special scales for measuring case-hardened specimen.

STANDARDS

- European & international EN ISO 6508
- American ASTM E18

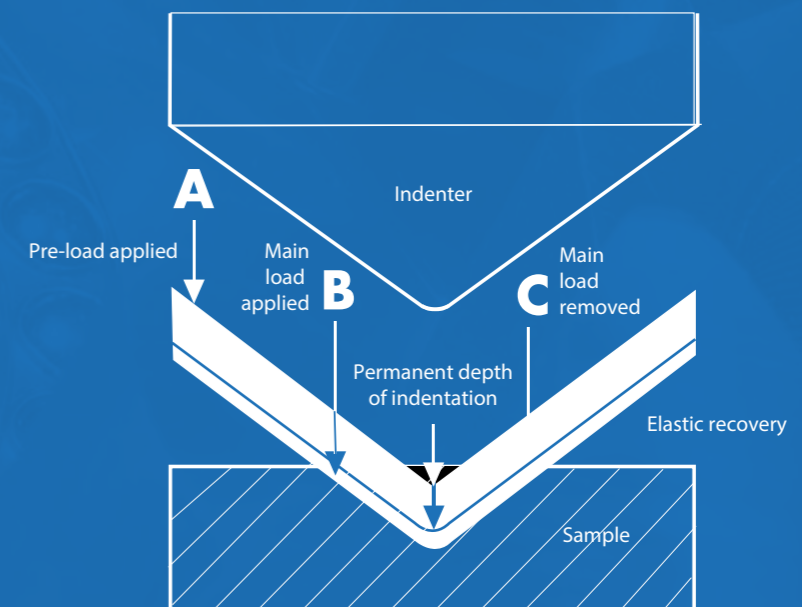

ROCKWELL HARDNESS TESTERS

OVERVIEW

Rockwell hardness testing, from traditional hand operated machines, to load cell, force feedback, closed loop testers with high performance. For regular use in workshops, or to conduct testing on parts and components for public transportation vehicles or high tech aerospace related applications. For conventional industries up to top notch aerospace laboratories.



FENIX 200AR



FENIX 200ACL



FENIX 200DCL



NEXUS 605RS(B)



NEXUS 610RS(B)



VERZUS 710RS(B)



NEMESIS 6100



NEMESIS 6200



NEMESIS 9100RSB

A WIDE RANGE, CONNECTING TO YOUR REQUIREMENTS...

INNOVATEST provides a full line-up of Rockwell testers for any application and for any budget.

Our Rockwell testing instruments are routinely used for testing materials at metal workshops, laboratories, schools, universities all during normal day-shift. The 710 series is the workhorse in the range. It is designed for 24/7 use and conducts testing at a high speed.

For those demanding a fixed work piece position and measurements at the highest possible accuracy, fully automatic at high speed, the NEMESIS 6100 and 6200 series are the state-of-the-art solutions to go for.

FENIX 200 AR/ACL/DCL

NEXUS 605/610



Quality long life mechanics, readings from a precision indicator. Load applied from either a traditional dead-weight system (200AR) or a unique in this class, load cell closed loop system, the 200ACL or 200DCL.

The newly designed C-frame made out of massive steel bars, (no casting) provides 100% more rigidity compared to traditional casted designs and assures excellent GR&R results even after years of use. The internal system can be easily serviced by removing the side and top covers, no need to turn the machine upside down.

The ACL and the DCL version perform both Brinell and Rockwell, one of the advantages of the closed loop system.



FENIX 200DCL DISPLAY



The NEXUS 605 and the NEXUS 610 Rockwell hardness testers offer quality and durability.

The design and performance of these models make it actually best in its class. These Twin Scale models (Rockwell & Superficial Rockwell) can accommodate a wide variety of applications. The RSB models cover Brinell hardness testing from 1kgf up to 187.5kgf, in combination with an analogue microscope. Simply key in the measured diameters of the Brinell indent and testers calculate the Brinell value including statistics and conversion to other scales.

Both models have been developed for use in general metal workshops, laboratories, schools, universities and for industries that use hardness testers on a regular basis during an 8 hours shift.

FENIX 200AR

- SCALES** Rockwell.
- TEST FORCES** 10kgf pre-load, 60, 100, 150kgf main load.
- LOAD APP. SYSTEM** Manual, dead weight, via load selector.
- INDICATOR** Meets or exceeds the requirements of ASTM and ISO. Adjustable dial indicator reading 0.5 HR Rockwell units.
- BOTTOM SHELL** ABS, protects tester against falling objects.
- WORKPIECE ACC.** 260mm (H) X 150mm (D).

FENIX 200ACL/DCL

- SCALES** Rockwell & Brinell.
- TEST FORCES** 10kgf pre-load, 60, 100, 150kgf main load. All Brinell test forces from 10kgf -187.5kgf. Automatic, Load cell, closed loop, force feedback.
- LOAD APP. SYSTEM** Meets or exceeds the requirements of ASTM and ISO.
- INDICATOR** ACL: Adjustable dial indicator: reading 0.5 HR Rockwell units.
- DISPLAY** ACL: Dwell time, test force setting, scale selection, calibration. DCL: 5" full color touch screen.
- SOFTWARE** DCL: No. of tests, Mean, St. Deviation, Min., Max., Range, individual readings list, storage memory, Dwell time, test force setting, scale selection, calibration etc.
- MEMORY** DCL: Large internal memory stores 50 readings.
- OUTPUT** DCL: USB.
- ILLUMINATION** LED indenter & workpiece illumination.
- BOTTOM SHELL** ABS, protects tester against falling objects.
- WORKPIECE ACC.** 260mm (H) X 150mm (D).

HIGHLIGHTS :

- SCALES** Rockwell & Superficial Rockwell, Brinell (RSB model).
- TEST FORCES** 3, 10kgf pre-load, 60, 100, 150kgf main load. All Brinell test forces from 2.5kgf up to 187.5kgf (RSB model).
- LOAD APP. SYSTEM** Fully automatic, load cell, closed loop, force feedback.
- CONTROL/DISPLAY** **605** : i-Touch, 6.5" full color touch screen. **610** : Fully integrated Windows Controller, SSD hard disk, Windows 10 operated, IMPRESSIONS™ advanced workflow software, includes automatic measurement, keyboard & mouse. 6.5" industrial touch screen.
- SOFTWARE** No. of tests, Mean, St. Deviation, Min., Max., Range, CP, CPk, individual readings list, storage memory, Dwell time, test force setting, scale selection, calibration etc.
- MEMORY** **605** : Large internal memory stores 99 readings. **610** : Large internal memory stores 9999 readings.
- ILLUMINATION** Adjustable workpiece illumination.
- SPINDLE** Traditional cast iron frame with spindle and spindle bellows. Clamp to protect indenter and fix workpiece to anvil or stage.
- WORKPIECE ACC.** 260mm (H) X 165mm (D).
- OUTPUT** **605** : USB. **610** : Multi USB, CSV files, single readings, reports, printer.
- ANVILS** Anvils, stages, accessories as per detailed catalogue.



VERZUS 710

The VERZUS 710 RS(B) is constructed around a rock solid C-frame with supreme rigidity.

The closed loop system based on a load cell and precision force actuator guarantees the best GR & R results. The test forces can range from 1kgf to 250kgf and a full test cycle can be as little as 13 seconds (at a dwell time of 10 seconds).

Due to the depth measurement via an optical system a direct depth reading of 0.1 micron is a standard feature.

For demanding users the VERZUS can be equipped with a motorized spindle (optional) that lifts your work piece, without any effort, to the required testing position.



HIGHLIGHTS :

SCALES	Rockwell, Superficial Rockwell, Brinell (RSB model), HBT & HVT, Ball indentation for plastic ISO 2039/1.
TEST FORCES	3, 10 kgf pre-load; 15, 30, 45, 60, 100, 150kgf main load.
LOAD APP. SYSTEM	All Brinell test forces from 1kgf - 250kgf (RSB model). Fully automatic, Load cell, closed loop, force feedback.
CONTROL	Fully integrated Windows Controller, SSD hard disk, Windows 10 operated, IMPRESSIONS™ advanced workflow software, includes automatic measurement, keyboard & mouse.
DISPLAY	6.5" Industrial HD touch screen, embedded.
SOFTWARE	CSV files, single readings, reports, printer.
ADVANCED OUTPUT	No. of tests, Mean, St. Deviation, Min., Max., Range, CP, CPk, individual readings list, storage memory, Dwell time, test force setting, scale selection, calibration etc.
ILLUMINATION	Adjustable workpiece illumination.
SPINDLE	Traditional cast iron frame with spindle and spindle bellows. Clamp to protect indenter and fix workpiece to anvil or stage.
WORKPIECE ACC.	315mm (H) X 200mm (D).
ANVILS	Anvils, stages, accessories as per detailed catalogue.

NEMESIS 6100/6200

The 6100 and 6200 Series hardness testers are state-of-the-art machines. They feature an all linear force application system, with a descending test head and a fixed work piece position. This completely eliminates, any unwanted tolerance in the depth measurement.

The 6100/6200 models feature Load cell, force feedback, closed loop system, fully automatic, servo motor driven. These hardness testers can accommodate a wide variety of applications due to the IMPRESSIONS™ advanced hardness software.

Perfectly suitable for aircraft engine parts, automobile parts, production lines, general quality assurance and the highest standard for laboratory use.

HIGHLIGHTS :

SCALES	Rockwell & Superficial Rockwell, Brinell (RSB models).
TEST FORCES	3, 10kgf pre-load; 60, 100, 150kgf main load. All Brinell test forces from 1kgf - 250kgf (RSB models).
LOAD APP. SYSTEM	Fully automatic, Load cell, closed loop, force feedback.
CONTROL	6100 : i-Touch software. 6200 : Fully integrated Windows Controller, SSD hard disk, Windows 10 operated, IMPRESSIONS™ advanced workflow software, includes automatic measurement, keyboard & mouse.
DISPLAY	6100 : 6.5" color touch screen. 6200 : 15" full colour touch screen.
ADVANCED OUTPUT	6100 : USB, single readings, text file reports. 6200 : Multi USB, CSV files, single readings, reports, printer, Q-DAS cert.
LASER SOFTWARE	6200 : Built-in laser positioning system. No. of tests, Mean, St. Deviation, Min., Max., Range, CP, CPk, individual readings list, storage memory, Dwell time, test force setting, scale selection, calibration etc.
ILLUMINATION	Adjustable workpiece illumination.
Z-AXIS	Descending test head, with collision detection, CNC motorized, ball bearing spindle, with fast up down and joystick for fine adjustment.
XY-STAGE	Manual, motorized stages (6200) or/and anvils or work tables at choice.
WORKPIECE ACC.	345mm (H) X 220mm (D).

TOP NOTCH

THE LABORATORY STANDARD



NEMESIS 9100RS(B)

HIGHLIGHTS :

SCALES	Rockwell & Superficial Rockwell, Brinell (RSB model).
TEST FORCES	3, 10kgf pre-load; 60, 100, 150kgf main load. All Brinell test forces from up to 3000kgf.
LOAD APP. SYSTEM CONTROL	Fully automatic, Load cell, closed loop, force feedback. Integrated i7 Windows Controller, SSD hard disk, Windows 10 operated, IMPRESSIONS™ advanced workflow software, includes automatic measurement, keyboard & mouse.
DISPLAY	15" full color touch screen.
ADVANCED OUTPUT	Multi USB, CSV files, single readings, reports, printer, Q-DAS certified.
SOFTWARE	No. of tests, Mean, St. Deviation, Min., Max., Range, CP, CPk, individual readings list, storage memory, Dwell time, test force setting, scale selection, calibration etc.
ILLUMINATION	Adjustable workpiece illumination.
Z-AXIS	Descending test head, with collision detection, CNC motorized, ball bearing slide, with fast up down and digital scroll wheel for fine adjustment.
XY-STAGE WORKPIECE ACC.	Manual, motorized stages or/and anvils or work tables at choice. 9100RS : 415mm (H) X 220 mm (D). 9100RSB : 415mm (H) X 225 mm (D).

FORCE RANGES :

NEMESIS 9100RS	1 kgf - 250kgf
NEMESIS 9100RSB	1 kgf - 250kgf
NEMESIS 9103RSB	3kgf - 3000kgf

ROCK-SOLID MULTI PURPOSE

NEMESIS 9100RS(B), is the "big brother" of the 6200 series. This Rockwell/Brinell hardness testers frame is constructed for continuous use of 3000kgf test force, 20 X more than the requirement for Rockwell, and therefore very suitable for Brinell.

The ultimate rigid linear force actuator can be equipped with a variety of extensions. The 9103RS(B) workhorse conducts besides pure Rockwell & Superficial Rockwell hardness scales, a full load range up to 3000kgf.

This tester is often used to perform 24/7 testing in robotic systems, in-line systems and/or can be used for special stages and fixtures to conduct fully automatic testing on for instance crankshafts.



BRINELL TESTING

METHOD

The Brinell Hardness test is the oldest method of hardness testing commonly used today. It was invented in Sweden by Dr. Johan August Brinell in 1900. This test is often used to determine the hardness of castings and forgings whose grain structure is too coarse for accurate Rockwell or Vickers testing.

Almost all metals may be tested with the Brinell test by simply varying the ball size and test force. As long as the ball size to test force ratio remains constant, the results are considered accurate.

Results from the Brinell Hardness test are used extensively in industry as a basis of acceptance of commercial shipments, and for quality control purposes generally. These results may correlate with metallic characteristics such as: ductility, tensile strength, wear resistance, etc.

The Brinell test is an indentation hardness test consisting of two steps.

Step one, the indenter is brought in contact with the test specimen perpendicular to the surface and the specified test force is applied. The test force is held for the specified time and then withdrawn.

Step two, The diameter of the indentation is measured in at least two directions perpendicular to each other. The Brinell hardness value is computed from the mean of the diameter measurements by the use of a mathematical formula designed for this purpose, or more frequently from a chart based on the formula.

TYPICAL VALUES

The standard format for specifying tests can be seen in the example "HBW 10/3000". "HBW" means that a tungsten carbide (from the chemical symbol for tungsten) ball indenter was used, as opposed to "HBS", which means a hardened steel ball. The "10" is the ball diameter in millimeters. The "3000" is the force in kilograms force.

STANDARDS

- European & international EN ISO 6506
- American ASTM E10

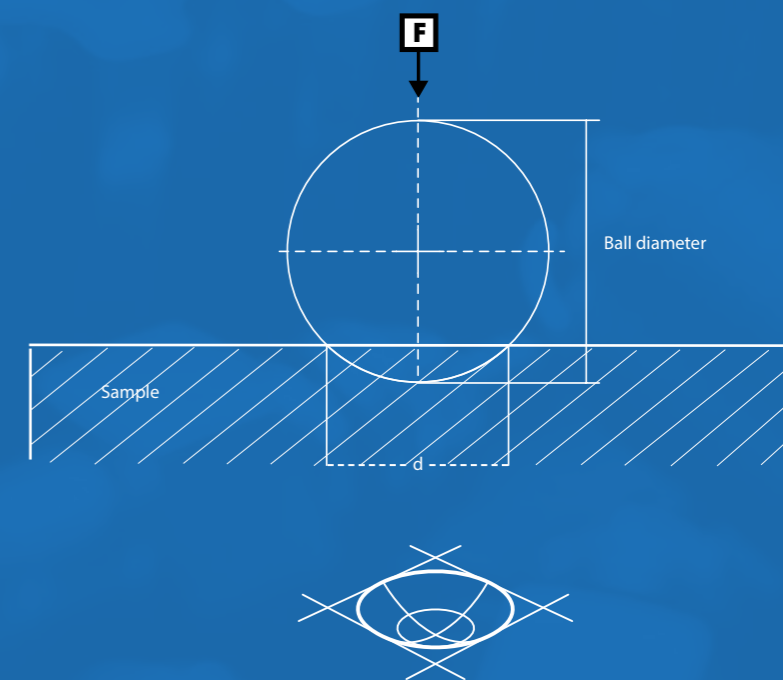

BRINELL HARDNESS TESTERS

OVERVIEW

Explore the wide diversity of our Brinell hardness tester range, starting from traditional microscope models or hand held BIOS scanners connected to integrated Windows controllers, to fully automatic models that include a 6 position turret, with 2 ring light objectives, combined with a HD 18 Megapixels camera to generate a crisp high-definition image.



NEXUS 3100



NEXUS 3200



NEXUS 3001XLM - IMP



NEXUS 3300/3400M



NEXUS 3300/3400FA



NEXUS 8103RSB



NEXUS 8103XLM-RSB



NEMESIS 9600RSB

OPTICAL & OR DEPTH READING? ...HB OR HBT, OR BOTH...

Analogue, digital or video systems; we also have a range of models that can measure according to the calibrated depth method (HBT) and conduct rapid testing.

Able to withstand the most harsh environments, if required with an air filtration system to protect the interior against dust. The Brinell machines have a very wide variety of workpiece accommodation.

NEXUS 3100/3200

NEXUS 3001XLM-IMP

Automatic Brinell hardness tester with analogue microscope and touch screen hardness calculator.

HIGHLIGHTS :

NEXUS 3100

SCALES	Brinell
TEST FORCES	62.5kgf - 3000kgf.
MICROSCOPE	Analogue microscope.
LOAD APP. SYSTEM	Fully automatic, Load cell, closed loop, force feedback.
CONTROL/DISPLAY	i-Touch, 6.5" industrial touch screen.
SOFTWARE	No. of tests, Mean, St. Deviation, Min., Max., Range, CP, CPk, individual readings list, storage memory, Dwell time, test force setting, scale selection, etc.
Z-AXIS	Manual or motorized.
CLAMP	Optional clamp to protect indenter and fix workpiece to anvil or stage.
WORKPIECE ACC.	220mm (H) X 220mm (D).
ANVILS	Anvils, stages, accessories as per detailed catalogue.



Fully automatic Brinell hardness testing system with automatic measurement.

HIGHLIGHTS :

NEXUS 3001XLM-IMP

SCALES	Brinell
TEST FORCES	30kgf - 3000kgf.
2 POSITION TURRET	1 indenter, 1 special Brinell objectives with ring lights.
CAMERA	5 Megapixels, Full HD camera system with zoom & auto-focus.
LOAD APP. SYSTEM	Fully automatic, Load cell, closed loop, force feedback.
CONTROL/DISPLAY	IMPRESSIONS™, 15" industrial touch screen.
SOFTWARE	No. of tests, Mean, St. Deviation, Min., Max., Range, CP, CPk, individual readings list, storage memory, Dwell time, test force setting, scale selection, calibration etc.
Z-AXIS	Manual or motorized.
WORKPIECE ACC.	345mm (H) X 220mm (D).
ANVILS	Anvils, stages, accessories as per detailed catalogue



Automatic Brinell hardness tester with Brinell indent optical scanner (BIOS) and automatic measurement.

NEXUS 3200

SCALES	Brinell
TEST FORCES	62.5kgf - 3000kgf.
MICROSCOPE	BIOS Brinell Indent Optical Scanner.
LOAD APP. SYSTEM	Fully automatic, Load cell, closed loop, force feedback.
CONTROL/DISPLAY	IMPRESSIONS™ LT, 6.5" industrial touch screen.
SOFTWARE	No. of tests, Mean, St. Deviation, Min., Max., Range, CP, CPk, individual readings list, storage memory, Dwell time, test force setting, scale selection, calibration etc.
Z-AXIS	Manual or motorized.
CLAMP	Clamp to protect indenter and fix workpiece to anvil or stage.
WORKPIECE ACC.	220mm (H) X 220mm (D).
ANVILS	Anvils, stages, accessories as per detailed catalogue.



HEAVY DUTY

ALL-ROUND

We provide solutions for nearly any size of parts or components. Stand-alone, inline, table type, floor type, radial arm type, test heads only. Solutions to your requirements, solutions for your needs.

NEXUS 3300-3400M

The NEXUS 3300-3400 has a fully enclosed body. Dust proof. Can either be accommodated with a manual spindle for semi-automatic testing or with a motorized spindle (the M-model) for fully automatic testing.

The standard included Brinell Indent Optical Scanner (BIOS) can be used on large or small components. One push on the button of the BIOS generates a crisp high definition image of the indent on the large full color touch screen. Automatic measurement provides instant Brinell readings.

The rock solid frame structure, covered with ABS shock absorbers, can withstand the harshest environment.

HIGHLIGHTS :

SCALES	Brinell.
TEST FORCES	62.5kgf - 3000kgf.
MICROSCOPE	BIOS Brinell Indent Optical Scanner.
LOAD APP. SYSTEM	Fully automatic, Load cell, closed loop, force feedback.
CONTROL	Fully integrated Windows Controller, SSD hard disk, Windows 10 operated, IMPRESSIONS™ advanced workflow software, includes automatic measurement.
DISPLAY	10.4" industrial touch screen.
SOFTWARE	Multi USB, CSV files, single readings, reports, printer.
ILLUMINATION	Power LED.
Z-AXIS	Manual or motorized.
WORKPIECE ACC.	Clamp to protect indenter and fix workpiece to anvil or stage. 3300 : 345mm (H) X 230mm (D) ; 3300M : 365mm (H) X 230mm (D) 3400 : 520mm (H) X 280mm (D) ; 3400M : 485mm (H) X 280mm (D)
ANVILS	Anvils, stages, accessories as per detailed catalogue.



NEXUS 3300-3400FA

Top of the range Brinell hardness testers with fully automatic indent video measuring system.

The NEXUS 3300-3400 FA are equipped with a 6-position motorized turret, with 3 indenter positions, a laser positioning system and 2 LWD objectives with ring lights. The stunning 18 Megapixel video system provides fast crisp images of the indent.

Simply press the START button and the testing result will be displayed automatically. The full test sequence runs automatic. The IMPRESSIONS™ advanced hardness testing software with indent ZOOM function includes many options for scale conversion, file storage, report printing, test program storage and more. Optional motorized CNC XY-stages can be installed for further automation.

HIGHLIGHTS :

SCALES	Brinell.
TEST FORCES	62.5kgf - 3000kgf.
6 POSITION TURRET	3 indenters, 2 special Brinell objectives with ring lights and laser positioning system.
CAMERA	18 Megapixels, Full HD camera system with zoom & auto-focus.
LOAD APP. SYSTEM	Fully automatic, Load cell, closed loop, force feedback.
CONTROL	Fully integrated Windows Controller, SSD hard disk, Windows 10 operated, IMPRESSIONS™ advanced workflow software, includes automatic measurement, keyboard & mouse.
DISPLAY	15" full color touch screen.
SOFTWARE	Multi USB, CSV files, single readings, reports, printer.
ILLUMINATION	Ring lights.
Z-AXIS	Motorized.
WORKPIECE ACC.	3300 : 365mm (H) X 230mm (D). 3400 : 485mm (H) X 280mm (D).
ANVILS	Anvils, stages, accessories as per detailed catalogue.



NEXUS 8103RSB/XLM-RSB

NEMESIS 9600RS(B)

The 8103 series are heavy duty hardness testers, robust, rigid, heavy duty design suitable for HBT measurement and contain high-quality mechanical components. Load cell, closed loop force feedback system. Unique in its class, the NEXUS 8103 series have a descending test head and a manual or motorized Z-Axis spindle. This provides a flexible working height and automated test head operation.

Aircraft engine parts, automobile parts and production lines are all covered by the NEXUS 8103. The NEXUS 8103 is developed as a fast Brinell Depth measuring system. The optional supplied BIOS scanner allows to conduct optical measurements too.



HIGHLIGHTS :

SCALES	Brinell, Rockwell, Superficial Rockwell.
TEST FORCES	3kgf - 3000kgf.
MICROSCOPE	BIOS Brinell Indent Optical Scanner.
LOAD APP. SYSTEM	Fully automatic, Load cell, closed loop, force feedback.
CONTROL	Fully integrated Windows Controller, SSD hard disk, Windows 10 operated, IMPRESSIONS™ advanced workflow software, includes automatic measurement, keyboard & mouse.
DISPLAY	15" full color touch screen.
SOFTWARE	Multi USB, CSV files, single readings, reports, printer, Q-DAS certified.
ILLUMINATION	Power LED.
Z-AXIS	Manual or motorized.
CLAMP	Clamp to protect indenter and fix workpiece to anvil or stage.
WORKPIECE ACC.	8103 : 380mm (H) X 260mm (D) 8103 XL : 580mm (H) X 285mm (D).
ANVILS	Anvils, stages, accessories as per detailed catalogue.

The floor type Brinell hardness tester NEMESIS 9600RS(B) is equipped with a heavy duty motorized spindle, allowing to position the test piece on the required working height.

The descending test head (second Z-axis) allows each sample to be tested on an ergonomic working height.

The linear actuator of the NEMESIS 9600RSB is equipped with a (multi) load cell closed loop system guaranteeing excellent accuracy and a wide range of fast testing procedures.

HIGHLIGHTS :

SCALES	Brinell, Rockwell, Superficial Rockwell.
TEST FORCES	3kgf - 3000kgf.
MICROSCOPE	BIOS Brinell Indent Optical Scanner.
LOAD APP. SYSTEM	Fully automatic, Load cell, closed loop, force feedback.
CONTROL	Fully integrated Windows i7 Controller, SSD hard disk, Windows 10 operated, IMPRESSIONS™ advanced workflow software, includes automatic measurement, keyboard & mouse.
DISPLAY	15" full color touch screen.
SOFTWARE	Multi USB, CSV files, single readings, reports, printer, Q-DAS certified.
ILLUMINATION	Power LED.
Z-AXIS	Motorized, lifts up to 800 kg.
CLAMP	Clamp to protect indenter and fix workpiece to anvil or stage.
WORKPIECE ACC.	650mm (H) X 395mm (D).
ANVILS	Anvils, stages, accessories as per detailed catalogue.

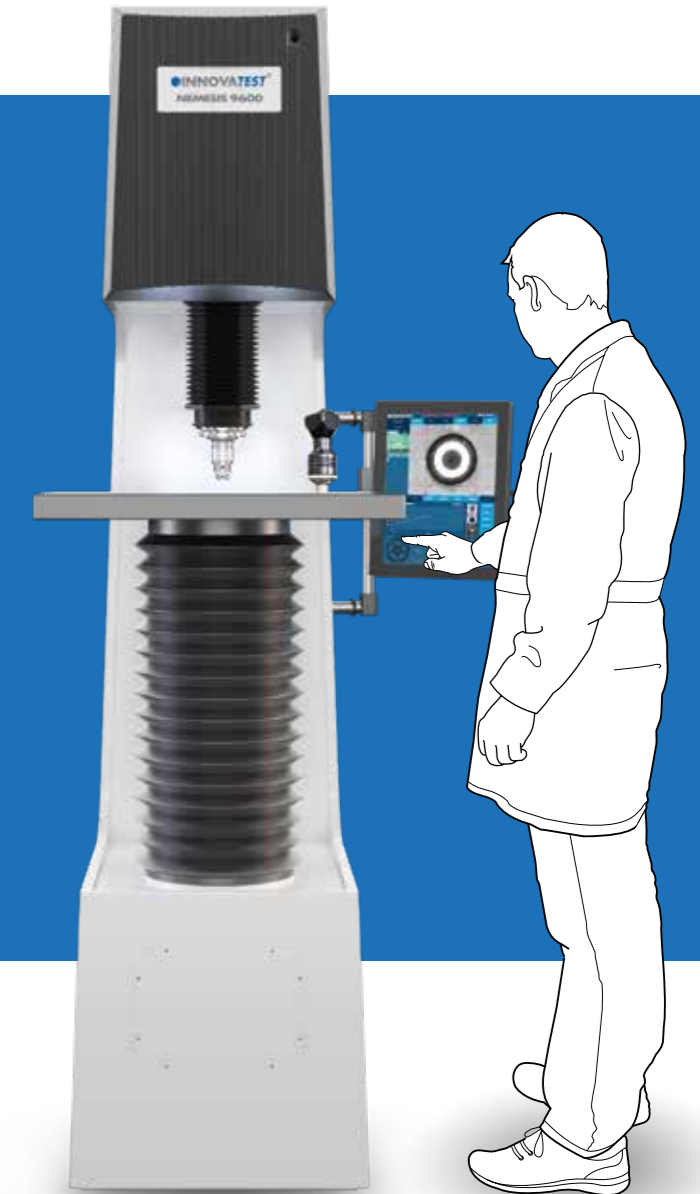

FORCE RANGES :

NEMESIS 9600RS	1 kgf - 250kgf
NEMESIS 9600RSB	1 kgf - 250kgf
NEMESIS 9603RSB	3kgf - 3000kgf

HARDNESS TESTING

UNIVERSAL

Universal hardness testers are in fact hybrid instruments allowing the user to carry out Rockwell, Vickers and Brinell hardness tests according to the applicable ISO, ASTM and JIS standards, with one single machine. Universal hardness testers do not convert hardness values but apply tests in each scale according to the standard procedures applicable for such a scale.

While most hardness testers in particular measure only one kind of scale either Rockwell or Vickers or Brinell, Universal testers cover a wide range of test loads and measurement procedures. Convenient for the user that does not need to change its set up for testing one part with different methods and cost reduction as only one tester needs to be purchased, calibrated and maintained.

While traditional Universal hardness testers were complex mechanical structures, built of many parts and complicated weight stacks, newer generations based on load cell technology and closed loop force feedback systems have taken away most of the complexity of earlier models.

Nowadays, Universal hardness testers offer the user the comfort of having one single tester covering all scales. The advantage is obvious; While Universal hardness testers are often a more expensive asset, money can be saved on maintenance, after sales service and calibration. Due to technology of the load application system, closed loop Universal hardness testers offer a wide range of test loads generally superseding single scale testers traditionally having dead weight load application systems.

We welcome your special attention for the NEMESIS 9100 series as a unique in its class machine, offering a load range of 200gf up to 3000kgf in a single hardness tester.

INNOVATEST manufactures a vast range of Universal hardness testers. Regardless of your budget, there is a tester for each application. Easy to operate, very advanced models to state-of-the-art machines.

TESTING METHODS



VICKERS, HV, HVT



KNOOP



BRINELL, HB, HBT



ROCKWELL, SUPER ROCKWELL

**CARBON,
CRACK DETECTION**

AND MORE...

UNIVERSAL HARDNESS TESTERS

OVERVIEW



STATE-OF-THE-ART HARDNESS TESTING

INNOVATEST offers the most comprehensive range of Universal hardness testing machines in the world.

Fit to any budget, our state-of-the-art universal hardness testing machines use innovative technology, meaning testing in a wide range of applications, with a high-precision level. While most hardness testers in particular measure only one kind of scale (either Rockwell or Vickers or Brinell), our Universal testers cover a wide range of test loads and measurements according to standard procedures.

No need to buy different machines for various scales!



NEXUS 605U



VERZUS 750CCD



NEMESIS 5100



NEMESIS 9100



NEXUS 7700



NEXUS 8100/8100XL



NEMESIS 9600



NEXUS 605U

The NEXUS 605U universal hardness tester main body is a fine casted rigid structure which incorporates a load cell, closed loop force actuator providing continuous force feedback information. Rockwell, Superficial Rockwell, Brinell, Vickers & Knoop hardness testing procedures can be conducted according to ISO and ISTM standards. The NEXUS 605U fits perfectly within many small metal working companies, schools and universities.

SCALES	Rockwell, Superficial Rockwell, Brinell, Vickers, Knoop.
TEST FORCES	2.5kgf - 187.5kgf
LOAD APP. SYSTEM	Fully automatic, Load cell, closed loop, force feedback.
MICROSCOPE	Electronic micrometer eyepiece or Analogue eyepiece.
CONTROL/DISPLAY	i-Touch, 6.5" full color touch screen.
SOFTWARE	No. of tests, Mean, St. Deviation, Min., Max., Range, CP, CPk, individual readings list, storage memory, Dwell time, test force setting, scale selection, calibration etc.
ILLUMINATION	Adjustable workpiece illumination.
FRAME	Traditional cast iron frame with spindle and spindle bellows.
CLAMP	Clamp to protect indenter and fix workpiece to anvil or stage.
WORKPIECE ACC.	260mm (H) X 165mm (D).
ANVILS	Anvils, stages, accessories as per detailed catalogue.



NEXUS 7700

The traditional swivel system (indenter/objective) universal hardness tester previously equipped with a matt screen, nowadays has a modern video indent measuring system with 18 Megapixels camera, an ultra-fast Windows i7 controller, automatic measurement and can be used for all hardness procedures; Brinell, Vickers, Knoop, HVT and HBT according to DIN, ISO standards.

The NEXUS 7700 also covers all Rockwell and Superficial Rockwell hardness scales. The tester can be equipped with an automatic motorized spindle which makes it possible to position your workpiece without any effort. In combination with a manual or motorized CNC XY-stage the tester offers the option of running case depth hardness programs, pre-defined testing patterns and/or other specific or special tasks defined by the user.

Perfectly suitable for testing hardness of castings and forgings, wide application within the automotive and aerospace industry or laboratory and workshop testing.



HIGHLIGHTS :

SCALES	Rockwell, Superficial Rockwell, Brinell, Vickers, Knoop.
TEST FORCES	0.5kgf - 250kgf.
CAMERA	18 Megapixels, Full HD camera system, with zoom and autofocus.
LOAD APP. SYSTEM	Fully automatic, Load cell, closed loop, force feedback.
CONTROL	Fully integrated Windows Controller, SSD hard disk, Windows 10 operated, IMPRESSION advanced workflow software, includes automatic measurement, keyboard & mouse.
DISPLAY	12" full color touch screen.
ADVANCED OUTPUT	Multi USB, CSV files, single readings, reports, printer, Q-DAS certified.
SOFTWARE	No. of tests, Mean, St. Deviation, Min., Max., Range, CP, CPk, individual readings list, storage memory, Dwell time, test force setting, scale selection, calibration etc.
ILLUMINATION	Adjustable workpiece illumination.
SPINDLE	Manual
CLAMP	Clamp to protect indenter and fix workpiece to anvil or stage.
XY-STAGE	Manual, motorized stages or/and anvils or work tables at choice.
WORKPIECE ACC.	340mm (H) X 205mm (D).

VERZUS 750CCD

This closed loop universal hardness tester is constructed around a rock solid C-frame. Optical automatic image evaluation combined with intuitive operator software avoids operator influence on the test results. Ideal for smaller workshops, educational purposes and for those who want to be versatile in hardness measurement with a larger scale of automation.

SCALES	Rockwell, Superficial Rockwell, Brinell, Vickers, Knoop, Carbon, HVT, HBT.
TEST FORCES	1kgf - 250kgf.
MICROSCOPE	Electronic micrometer eyepiece or Analogue eyepiece.
LOAD APP. SYSTEM	Fully automatic, Load cell, closed loop, force feedback
CONTROL	Fully integrated Windows Controller, SSD hard disk, Windows 10 operated, IMPRESSIONS™ advanced workflow software, includes automatic measurement, keyboard & mouse.
DISPLAY	8.5" industrial touch screen.
SOFTWARE	Multi USB, CSV files, single readings, reports, printer.
ILLUMINATION	Adjustable LED; ring light for dark field illumination (opt.)
SPINDLE	Manual or motorized. Clamp to protect indenter and fix workpiece to anvil or stage.
WORKPIECE ACC.	315mm (H) X 200mm (D).
ANVILS	Anvils, stages, accessories as per detailed catalogue.



NEMESIS 5100

The NEMESIS 5100 Universal hardness testing systems provide exceptional performance and are designed with enhancements that deliver unparalleled accuracy and reliability, improved ergonomics and an overall enhanced and pleasant experience for the operator.

The IMPRESSIONS™ tester control and workflow software, forms an integral component of the testing system.

Decreasing set-up time and increasing testing efficiency through the use of programmable test patterns and specific designed software applications, developed upon the request of demanding users. NEMESIS 5100 testing instruments are routinely used for testing metals and plastics, in the aerospace and automotive industry, laboratories for sample evaluation, or to conduct common but versatile testing tasks.



TURRET TECHNOLOGY



- 1 POWER LED BANKS
- 2 PROTECTION SKIRT
- 3 LASER POSITIONING SYSTEM
- 4 3 OBJECTIVES

HIGHLIGHTS :

- SCALES**
 - TEST FORCES**
 - CAMERA**
 - OVERVIEW CAMERA**
 - OBJECTIVES**
 - 8 POSITION TURRET**
 - ILLUMINATION CONTROL**
 - Z-AXIS**
 - XY-STAGE**
 - JOYSTICK**
 - WORKPIECE ACC.**
 - OUTPUT SOFTWARE**
- Rockwell, Superficial Rockwell, Brinell, Vickers, Knoop.
10gf - 3000kgf (multi load cell, closed loop).
18 Megapixels, Full HD camera system, with zoom and auto-focus.
Full HD optical zoom stage overview camera.
0.7X, 2.5X, 5X, 10X, 20X, 40X, 60X, 100X.
3 indenters, 3 objectives, Class 2 laser for positioning and integrated overview camera.
Power LED.
Fully integrated i7 Controller, Windows 10 operated, 15" industrial touch screen, IMPRESSIONS™ advanced workflow software, includes automatic measurement, stage control & pattern configurator, key board & mouse.
Descending test head, with collision detection, CNC motorized, ball bearing slide, with fast up down and digital scroll wheel for fine adjustment.
Manual, motorized stages or/and anvils or work tables at choice.
X-Y-Z control over integrated joystick.
150mm (H) X 230mm (D).
USB, LAN, Bluetooth.
Large choice of software options, features, plug-ins and add-ons, Q-DAS certified.

TRULY UNIVERSAL

NEMESIS 9100

The NEMESIS 9100 Universal hardness testing systems provide exceptional performance and are designed with enhancements that deliver unparalleled accuracy and reliability, improved ergonomics and an overall enhanced and pleasant experience for the operator.

The IMPRESSIONS™ tester control and workflow software, forms an integral component of the testing system. Decreasing set-up time and increasing testing efficiency through the use of programmable test patterns and specific designed software applications, developed upon the request of demanding users.

SCALES	Rockwell, Superficial Rockwell, Brinell, Vickers, Knoop
TEST FORCES	200gf - 3000kgf (multi load cell, closed loop).
CAMERA	18 Megapixels, Full HD camera system, with zoom and auto-focus.
OVERVIEW CAMERA	Full HD optical zoom stage overview camera.
OBJECTIVES	0.7X, 2.5X, 5X, 10X, 20X.
8 POSITION TURRET	3 indenters, 3 objectives, Class 2 laser for positioning and integrated overview camera.
ILLUMINATION	Power LED.
CONTROL	Fully integrated i7 Controller, Windows 10 operated, 15" industrial touch screen, IMPRESSIONS™ advanced workflow software, includes automatic measurement, stage control & pattern configurator, key board & mouse.
Z-AXIS	Descending test head, with collision detection, CNC motorized, ball bearing slide, with fast up down and digital scroll wheel for fine adjustment.
XY-STAGE	Manual, motorized stages or/and anvils or work tables at choice.
JOYSTICK	X-Y-Z control over integrated joystick.
WORKPIECE ACC.	300mm (H) X 225mm (D).
OUTPUT	USB, LAN, Bluetooth.
SOFTWARE	Large choice of software options, features, plug-ins and add-ons, Q-DAS certified.



TURRET TECHNOLOGY

The Turret technology of the NEMESIS 5100 also applies to the NEMESIS 9100.

NEXUS 8100/8100XL



UNIVERSAL

ROBUST, STURDY & RIDGID

The NEXUS 8100 standard and XL are dual Z-axis Universal hardness Testers. Not only can the spindle be located at any position in height, the test head with 50mm stroke will then conduct all testing, to reduce that spindle movement to a minimum.

It can be seen as the best of two worlds, having workpiece accommodation freedom and conducting testing at visual height.

The range contains high-quality mechanical components and is equipped with an 18 Megapixels integrated camera with calibrated zoom function guaranteeing fast and accurate user-independent measurements.

The sturdy design of the NEXUS 8100 (XL) allows rough workshop conditions. Aircraft engine parts, automobile parts, production line integration, general quality assurance and laboratory use are all fields covered by the NEXUS 8100 (XL).

HIGHLIGHTS :

SCALES	Rockwell, Superficial Rockwell, Brinell, Vickers, Knoop, HVT & HBT, Plastic ISO 2039/1, Carbon.
TEST FORCES	200gf - 3000kgf.
CAMERA	18 Megapixels, Full HD camera system, with zoom and autofocus.
OVERVIEW CAMERA	Full HD optical zoom stage overview camera.
8 POSITION TURRET	3 indenters, 3 objectives, Class 2 laser for positioning and optional integrated overview camera.
OBJECTIVES	0.7X, 2.5X, 5X, 10X, 20X, 40X, 60X, 100X. Fully automatic, Load cell, closed loop, force feedback.
LOAD APP. SYSTEM	Fully integrated Windows Controller, SSD hard disk, Windows 10 operated,
CONTROL	IMPRESSIONS™ advanced workflow software, includes automatic measurement, keyboard & mouse.
DISPLAY	15" full color touch screen.
ADVANCED OUTPUT	Multi USB, CSV files, single readings, reports, printer, Q-DAS certified.
SOFTWARE	No. of tests, Mean, St. Deviation, Min., Max., Range, CP, CPk, individual readings list, storage memory, Dwell time, test force setting, scale selection, calibration etc.
ILLUMINATION	Power LED.
SPINDLE	Manual or motorized, ball bearing slide, with fast up down and digital scroll wheel for fine adjustment.
XY-STAGE	Manual, motorized stages or/and anvils or work tables at choice.
WORKPIECE ACC.	8100 : 350mm (H) X 260mm (D) or XL model : 550mm (H) X 285mm (D).

NEMESIS 9600

NEMESIS 9800

The NEMESIS 9600 is a heavy-duty floor type universal hardness tester most suitable for harsh testing conditions of very large parts. This floor type frame reaches a height of 2 meters and offers a workspace of not less than 650mm height and a throat depth of 395mm from spindle center.

The heavy duty motorized spindle with over 800 kg lifting capacity allows to position the test piece on the required working height. Rockwell, Vickers and Brinell, but also pure depth test methods such as HVT and HBT are part of the standard test procedures of the NEMESIS 9600.

The second Z-axis has a 150mm stroke descending test head which gives unique flexibility.

This custom-made universal hardness tester with a force range of 1kgf - 3000kgf covers all hardness scales: Brinell, Vickers, Knoop, Rockwell, Superficial Rockwell, HVT & HBT, Ball indentation for plastic ISO 2039/1.

The motorized descending test head can be equipped with 6, 7 or 8 position turret and has standard 3 indenters and 3 objectives. The IMPRESSIONS™ full tester and configuration control can be easily operated by means of the 15" industrial HD Touch screen. Due to the enormous workpiece accommodation of 1500mm (H) X 1500mm (D), the NEXUS 9800 is perfectly suitable for heavy and very large parts.

The second Z-axis has a 150mm/300mm stroke descending test head offering unique flexibility.

HIGHLIGHTS :

SCALES	Rockwell, Superficial Rockwell, Brinell, Vickers, Knoop, HVT & HBT, Plastic ISO 2039/1, Carbon.
TEST FORCES	200gf - 3000kgf.
CAMERA	18 Mega pixel, Full HD camera system, with zoom and autofocus.
OVERVIEW CAMERA	Full HD optical zoom stage overview camera.
8 POSITION TURRET	3 indenters, 3 objectives, Class 2 laser for positioning and optional integrated overview camera.
OBJECTIVES	0.7X, 2.5X, 5X, 10X, 20X, 40X, 60X, 100X.
LOAD APP. SYSTEM	Fully automatic, Load cell, closed loop, force feedback.
CONTROL	Fully integrated Windows Controller, SSD hard disk, Windows 10 operated, IMPRESSIONS™ advanced workflow software, includes automatic measurement, keyboard & mouse.
DISPLAY	15" full color touch screen.
ADVANCED OUTPUT	Multi USB, CSV files, single readings, reports, printer, Q-DAS certified.
SOFTWARE	No. of tests, Mean, St. Deviation, Min., Max., Range, CP, CPk, individual readings list, storage memory, Dwell time, test force setting, scale selection, calibration etc.
ILLUMINATION	Power LED.
Z-AXIS	CNC motorized, ball bearing slide, with fast up down and digital scroll wheel for fine adjustment.
XY-STAGE	Manual, motorized stages or/and anvils or work tables at choice.
WORKPIECE ACC.	9600 : 650mm (H) X 395mm (D). 9800 : 1500mm (H) X 1500mm (D).



IN-LINE TEST HEADS

INNOVATEST test heads can be supplied with integrated or external (table or floor mounted) operating console. The test heads can be fully integrated in product manufacturing lines.

The IMPRESSIONS™ software controls the entire unit and communicates with external control or quality systems.

HIGHLIGHTS :

SINGLE TEST HEAD

SCALES	Rockwell, Superficial Rockwell, HVT & HBT, Ball indentation for plastic ISO 2039/1.
TEST FORCES	1kgf - 250kgf (UN-HEAD250SI) 3kgf - 3000kgf (UN-HEAD3000SI)
LOAD APP. SYSTEM	Load cell, force feedback, closed loop system.
DISPLAY	15" Industrial HD Touch screen, Embedded.
CONTROL	Powerful Fanless System Controller, 2X 80GB SSD data storage drive Windows 7 Embedded, IMPRESSIONS™ advanced workflow software, includes automatic measurement, indent ZOOM function, key board & mouse.
Z-AXIS	Descending test head with single indenter position and workpiece clamp.
DRIVER PACK	Built-in driver for X-Y or Jominy stages.

UNIVERSAL TEST HEAD

SCALES	Brinell, Vickers, Knoop, Rockwell, Superficial Rockwell, HVT & HBT, Ball indentation for plastic ISO 2039/1.
TEST FORCES	200gf - 250kgf (UN-HEAD250) 200gf - 3000kgf (UN-HEAD3000)
LOAD APP. SYSTEM	Load cell, force feedback, closed loop system.
DISPLAY	15" Industrial HD Touch screen, Embedded.
CONTROL	Powerful Fanless System Controller, 2X 80GB SSD data storage drive Windows 7 Embedded, IMPRESSIONS™ advanced workflow software, includes automatic measurement, indent ZOOM function, key board & mouse.
Z-AXIS	Descending test head with 6, 7 or 8 position turret, standard 3 indenters, 3 objectives.
DRIVER PACK	Built-in driver for X-Y or Jominy stages.





DISCOVER
OUR REFERENCE

TESTERS

REFERENCE HARDNESS

TESTERS

REFERENCE & STANDARDIZATION HARDNESS TESTING MACHINES

INNOVATEST manufactures standardization / calibration hardness testing machines for national laboratories, hardness test block manufacturers or industries that require not only a hardness tester, but a machine that provides results with the lowest possible uncertainty.

Since our hardness tester are based on unparalleled accurate mechanics, basically each of our standard products meets the mechanical requirements of a standardizing machine.

To assure the lowest possible measuring uncertainty, these reference machines are fitted with sophisticated ultra-high precision force, depth and diameter sensors, 18 Megapixels camera system and best in class optics. Our Rockwell machines provide a depth measuring system with 0,02micron resolution.

Force is applied and repeated with a tolerance of less than 0,05%.

Our standard range of reference/standardizing machines are available for Rockwell, Vickers, Knoop and Brinell, covering a force range of 10gf up to 3000kgf. Each of the machines can be prepared with all kinds of automation and communication output. All models are Q-Das quality system certified.



FALCON 600 LAB

Standardizing tester for Vickers scales

Equal to FALCON 600, but with enhanced accuracy.

TEST FORCES 10gf - 62.5kgf



FALCON 5002 LAB

Standardizing tester for Vickers scales

Equal to FALCON 5000, but with enhanced accuracy.

TEST FORCES 100gf - 187.5kgf



NEMESIS 5100RS LAB

Standardizing tester for Rockwell scales

Equal to NEMESIS 5100, but with enhanced accuracy.

TEST FORCES 3kgf - 150kgf

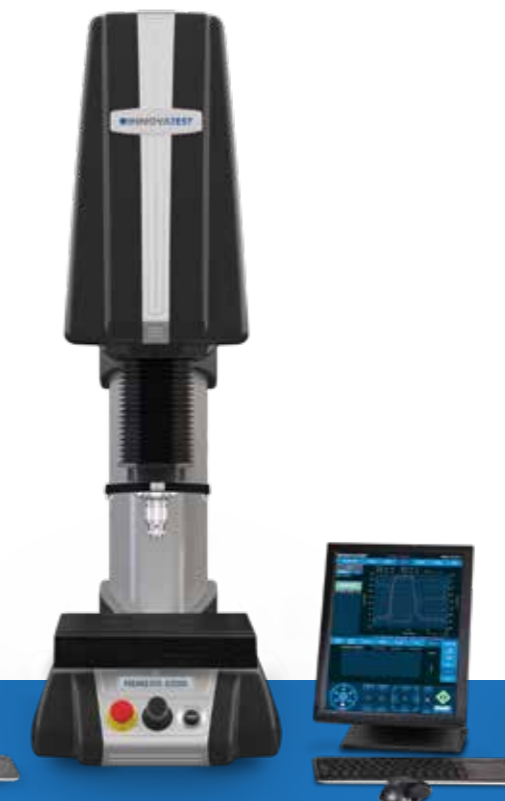

NEMESIS 6200RS LAB

Standardizing tester for Rockwell scales

Equal to NEMESIS 6200, but with enhanced accuracy.

TEST FORCES 3kgf - 150kgf



NEMESIS 9103B LAB

Standardizing tester for Brinell scales

Equal to NEMESIS 9100, but with enhanced accuracy.

TEST FORCES 10kgf - 3000kgf

“Reliability is the pre-condition for trust...”

The I-Touch™ software provides clever multi-function keys for testing, set-up, storing and uploading of test programs, statistic control and more, making tester operation as easy as it can be. Data export, single or batch readings, with a single press on a button, or just fully automatic after measurement can be stored on a USB stick or transfer by cable to a PC to be imported or evaluated in EXCEL.

Further advanced features include extended statistics, shape correction for convex, concave or ball shaped specimens, hardness conversion to Rockwell, Brinell or Tensile strength according to ASTM E140 and ISO 18625 with different material tables.

There is a table top panel with a adjustable viewing angle or an integrated version imbedded in the testers frame. In all cases, the panel is mounted in a solid robust aluminum frame.



STARTING WITH I-TOUCH

INNOVATIVE SOFTWARE FUNCTIONS

1 OUT OF SET LIMITS



2 UNMISTAKEN TURRET POSITION



3 MEASUREMENT OVERVIEW



4 EXPORT FUNCTIONS

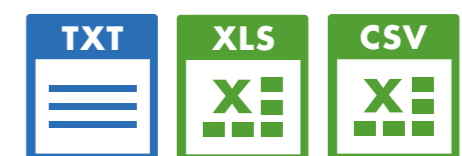

Science fiction?... No, just reality ahead of schedule

The Graphical User interface (GUI) contains Industry preferred applications and offers easy to learn, advanced workflow control. A simple test can be set up and conducted in about 3 seconds... IMPRESSIONS™ layout & functions will match not only your particular application requirements, but also meet the needs and preferences of your operators. A user level management system maximizes their comfort and efficiency.

The unique in the industry, 15" portrait mode, capacitive touch screen, gives room to all possible applications. Dual screen: For demanding users, a second vertical 15" or 24" landscape screen can be connected. For educational purposes, schools, universities, a full HD projector (beamer) can be connected to the HDMI supported outlet. With this many options in Hardware and Software configuration, yearly updates and on demand upgrades, IMPRESSIONS™ is truly the leading software in the industry.



FEATURED BY IMPRESSIONS v2

ADVANCED SOFTWARE APPLICATIONS

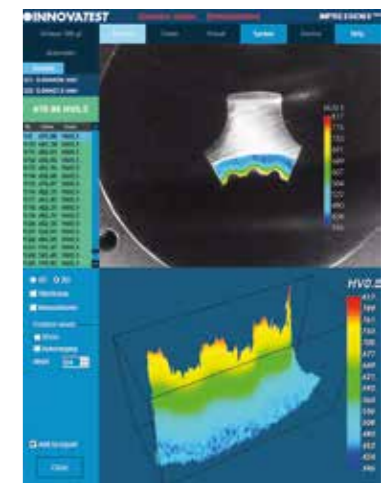
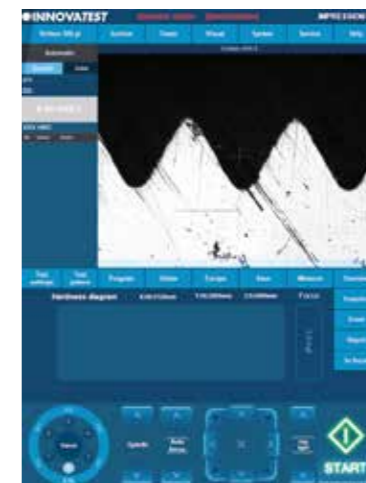

REFERENCE BLOCKS & INDENTERS

Reference blocks or hardness reference plates are comparison plates most commonly made of Steel or Aluminum but could also be made of Brass or custom materials.

They are used for the day to day Indirect Verification and Calibration of hardness testing machines and instruments. Adjusting your hardness tester according to the value engraved in a reference block, as long as the adjustments are minor, can be done after assurance that a correct and undamaged indenter/penetrator is installed and the tester operates normally.

CERTIFIED ISO & ASTM HARDNESS TEST BLOCKS

INNOVATEST hardness reference blocks are manufactured according to standards ISO (International) and ASTM (American). Such standards apply to the physical requirements as well to the method & the way the final value is found and confirmed. By adding a grid on the blocks they also meet the requirements of NADCAP.

INNOVATEST hardness reference blocks are not "just" hardness reference blocks. Our blocks are of excellent finish and have very low variation, excellent repeatability. They are calibrated by a UKAS accredited laboratory.

RAW MATERIALS USED, HEAT TREATMENT & FINISHING

In order to manufacture good hardness reference blocks, strict control over the quality of raw materials is elementary. The entire block material needs to be homogenous, to assure low spread of readings and excellent repeatability. Distribution of the blocks in the hardening furnaces is of utmost importance, time, temperature and quench are all carefully controlled processes, to assure a top class product. The next step in the process to ensure high quality "blanks" is the grinding, polishing and lapping of the block surfaces. Any concerns on the surface quality are eliminated due to thorough selection after inspection.



QUALITY CONTROL

Before proceeding with the ultimate verification and engraving of the block hardness, blocks are undergoing a full inspection to ensure that they meet the physical requirements of ISO and ASTM (thickness, flatness, parallelism, surface roughness). INNOVATEST hardness reference blocks are also compliant for the use by organizations or companies that are under the NADCAP Program. (National Aerospace and Defense Contractors Accreditation Program).

INNOVATEST offers a wide range of certified indenters for all machines in our product range. Indenters are available for all hardness scales. Please specify your machine type in all enquiries.

ROCKWELL, VICKERS & KNOOP INDENTERS

Diamonds are sourced worldwide, and are selected individually for size, shape and quality. Each diamond is orientated to achieve maximum life of the indenter.

Each diamond is sintered at high temperature and pressure into a tungsten carbide matrix in a stainless steel blank. This secures the diamond for the grinding and polishing stages before finishing the indenter body with CNC machining. The sintering process also ensures there is no movement of the diamond when placed under load which would result in inaccurate hardness test readings.



BALL INDENTERS

Our ball indenters are either made of steel or tungsten carbide.

All indenters can be supplied with either a standard factory certificate or an ISO/ASTM (Ukas/DAkks/ NVLAP/ A2LA) certificate.



SUPPORT YOUR BEST TESTING RESULTS

With our rigid designed Bench stands

- Rock solid bench stands
- 100% retractable drawer, bearing guidance, max 100kg load. Rubber anti slip bottom
- Lockable cabinet, 300mm high
- Adjustable feet, (+/- 50mm height adjustable to reach ergonomic working position)
- Made of corrosion resistant zinc plated steel with RAL powder coating
- Carrying capacity of 400kg
- Top surface made of 50mm Plywood with 1.5mm chemical resistant plastic plating, edges made of shock resistant 3mm ABS side liner
- Industrial quality, for workshop or laboratory

Designed for hardness testing instruments,
painted in INNOVATEST® RAL colors
matching our testers.



UN-STAND/960 71 X 75 X 80 cm
UN-STAND/950 71 X 75 X 70 cm
UN-STAND/955 71 X 90 X 57 cm
UN-STAND/956 71 X 90 X 42 cm



UN-STAND/965 150 X 75 X 80 cm

Distributor :

CORPORATE HEAD OFFICE

INNOVATEST Europe BV

Manufacturing, Distribution & Service

Borgharenweg 140
6222 AA MAASTRICHT
The Netherlands

Phone: +31 43 3520060

Fax: +31 43 3631168

info@innovatest-europe.com

www.innovatest-europe.com

INNOVATEST Deutschland GmbH Sales & Service

Phone: +49 245 670 59 500
info@innovatest-deutschland.com
www.innovatest-deutschland.com

INNOVATEST Polska sp. z.o.o Sales & Service

Phone: +48 697 099 826
info@innovatest-polska.pl
www.innovatest-polska.pl

INNOVATEST Shanghai Co., Ltd. Sales & Service

Phone: +86 21 60906200
info@innovatest-shanghai.com
www.innovatest-shanghai.com

INNOVATEST Japan Co., Ltd. Sales & Service

Phone: +81 3 3527 3092
info@innovatest-japan.com
www.innovatest-japan.com

INNOVATEST USA Company Sales & Service

Phone: +1 267 317 4300
info@innovatest-usa.com
www.innovatest-usa.com

INNOVATEST South East Asia Sales & Service

Phone: +65 6451 1123
info@innovatest-singapore.com
www.innovatest-singapore.com